

ORDER EXAMPLE

To correctly order this model follow the example specified below:

PRODUCT	BA20#080050 0B1 ST 9010
BA20#080050	Article code found in the prices table on the side
0B1	Connector code found in the table here below
ST	Standard Support code found in the table here below
9010	Colour code found in the TUBES COLOUR CHART
ACCESSORIES	
Z1TLNR#AN R12 9010	Valve and Lockshield - Copper angle 1/2" for copper pipes or multi-layer pipes - White RAL 9010
Z1RAC#R12CRO	12mm diam. copper pipe unions for Valve+Lockshield – chrome finish (2)

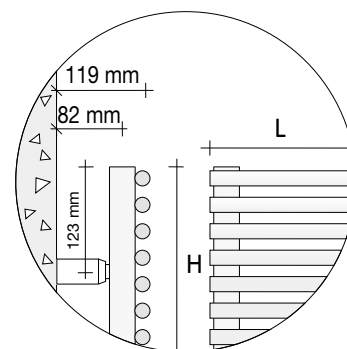

For other types of Valves see the table below or those on pages 271 - 272 - 273 - 274 - 275.

CONNECTORS

The towel warmers are supplied with "0B1" connectors.

If different connectors are required, strictly indicate this in the order. **IMPORTANT:** the connectors of towel warmers and radiators connected to the same system should all have the same configuration otherwise operating problems could occur.

Standard connectors

Will be supplied if not otherwise specified when placing the order

Rear connector

Supplied on request WITH an additional price charge of €

Custom-made connectors

Supplied on request WITH an additional price charge of €

Connectors on request

Supplied on request WITHOUT an additional price charge

Custom-made connectors

Supplied on request WITH an additional price charge of €

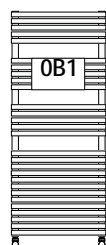

Interaxis (Pipe centre)
l=L-3,4 cm



l=L-3,4 cm
rear connector for connection to GVR

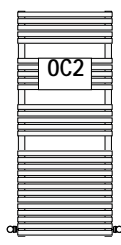

Interaxis (Pipe centre)
l=L+13,8 cm



Interaxis (Pipe centre)
l=H-7,0 cm



Interaxis (Pipe centre)
l=H-7,0 cm



single pipe

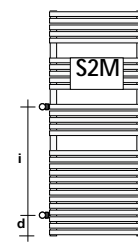

Specify "i" and "d"
i min.=5 cm d min.=2 cm

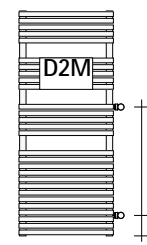

SUPPORTS

The towel warmers are supplied with standard supports (code ST) that include wall fixing shelves, pressure anchors and manual Vent Valve.

On request they can be ordered with bracket supports that are permanently welded on the towel warmers and therefore must be specified when placing the order, their code and cost are as follows:

code MD	WALL TYPE bracket support on the Right	€
code MS	WALL TYPE bracket support on the Left	€
code SO	CEILING TYPE bracket support	€

LIMITS

WALL TYPE bracket support	Width max 60.0 cm
CEILING TYPE bracket support	Width max 80.0 cm

The Chrome plated version cannot be supplied with bracket supports

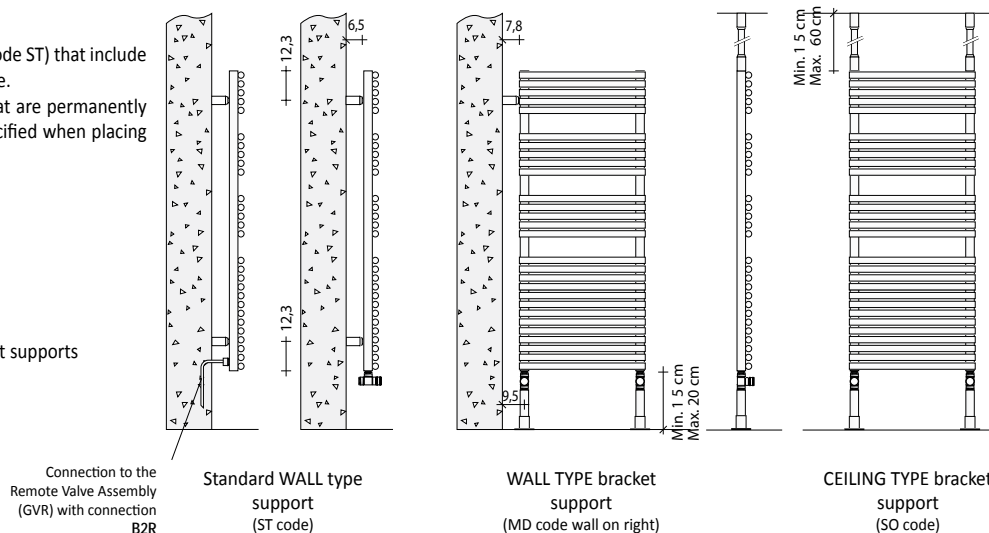

ADDITIONAL CHARGES FOR COLOURS AND FINISHES (see the official Tubes Colour Chart)

RAL colours not included in the colour chart + 30% more than Pure white price (cat. C0), for colours according to samples request feasibility and estimate.
PLATED finishes: NOT available

BATH 20

Price per radiator with White RAL 9010 finish and standard connectors - VAT and transport charges excluded

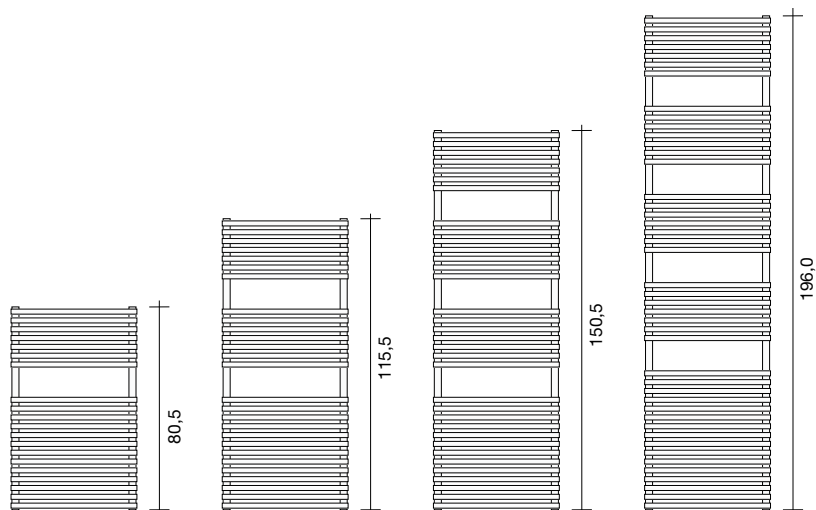

Code	H (cm)	L (cm)	Interaxis* (Pipe centre) (cm)	Water Content (l)	Coloured version		Category C0 RAL 9010 (€)	Category C1/C2 (€)	Category C3 (€)
					Watts ΔT 50°C	Watts ΔT 30°C			
BA20#080040	80,5	40,0	36,6	3,20	374	203			
BA20#080435		43,5	40	3,48	402	219			
BA20#080050		50,0	46,6	4,00	454	247			
BA20#080535		53,5	50	4,28	483	263			
BA20#080060		60,0	56,6	4,80	535	291			
BA20#080635		63,5	60	5,08	563	307			
BA20#120040	115,5	40,0	36,6	4,50	512	274			
BA20#120435		43,5	40	4,89	548	295			
BA20#120050		50,0	46,6	5,63	616	324			
BA20#120535		53,5	50	6,02	652	350			
BA20#120060		60,0	56,6	6,75	719	388			
BA20#120635		63,5	60	7,14	755	410			
BA20#150040	150,5	40,0	36,6	5,50	656	350			
BA20#150435		43,5	40	5,98	702	377			
BA20#150050		50,0	46,6	6,88	786	424			
BA20#150535		53,5	50	7,36	832	444			
BA20#150060		60,0	56,6	8,25	916	493			
BA20#150635		63,5	60	8,73	962	521			
BA20#190040	196,0	40,0	36,6	7,10	872	460			
BA20#190435		43,5	40	7,72	929	494			
BA20#190050		50,0	46,6	8,88	1036	555			
BA20#190535		53,5	50	9,50	1094	579			
BA20#190060		60,0	56,6	10,65	1201	641			
BA20#190635		63,5	60	11,27	1258	676			

* Inter-axis calculated with standard OB1 connectors

Towel warmers available in stock with OB1 connector and in White RAL 9010 colour

REMOTE VALVE ASSEMBLY

code	Description	Price
GVR#	Valve and Lockshield assembly for recessed remote connection, CHROME finish	€
GVRC#	Valve and Lockshield assembly for recessed remote connection, COLOUR finish	€

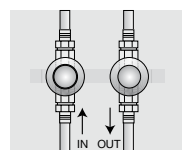

STANDARD VALVES (for Valves and Lockshields, valves that can be fitted with thermostat, Thermostatic valves, or Single pipe, Twin pipe, Stainless steel and thermostatic heads see pages 271, 272, 273, 274 and 275 of the Price List)

code / Description	Price
Z1TLNR#ANR129010 Paired Valve and Lockshield copper Angle 1/2" WHITE	€
Z1RAC#R12CRO 2 copper unions diam. 12 mm	CHROME €
ZRCF# Kit with pipe collars for towel warmers	WHITE €

BATH 20 i5

Towel warmer composed of horizontal fusion welded elements in 20 mm diameter steel with 34 mm diam. manifolds

HW

ORDER EXAMPLE

To correctly order this model follow the example specified below:

PRODUCT **BA20 i5#120050 0i5 ST 9010**
 BA20 i5#120050 Article code found in the prices table here below
 0i5 Connection code for 5 cm Interaxis (Pipe centre) (Pipe centre)
 ST Standard Support code found in the table here below
 9010 Colour code found in the TUBES COLOUR CHART

ACCESSORIES
 Z1TLNR#AN R12 9010 Valve and Lockshield - Copper angle 1/2" for copper pipes or multi-layer pipes - White RAL 9010
 Z1RAC#R12CRO 12mm diam. copper pipe unions for Valve+Lockshield – chrome finish (2)

For other types of Valves see the table below or those on pages 271 - 272 - 273 - 274 - 275.

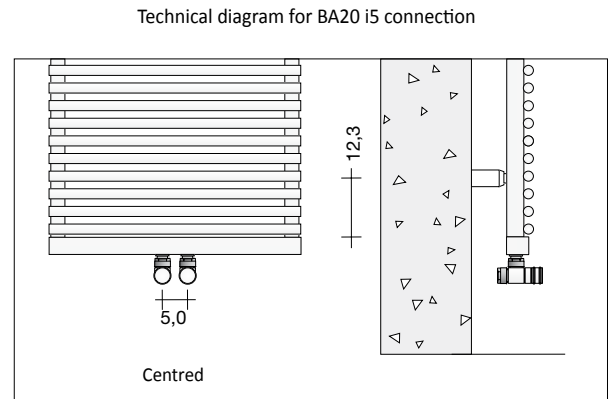
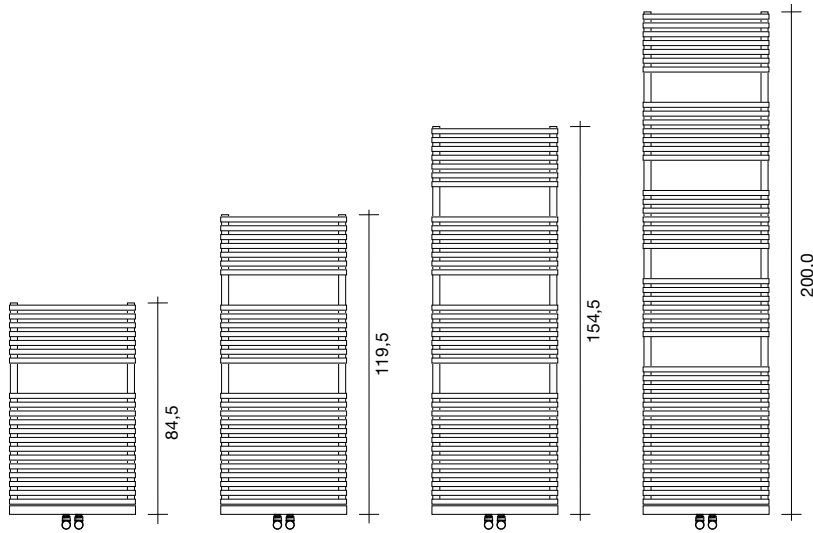
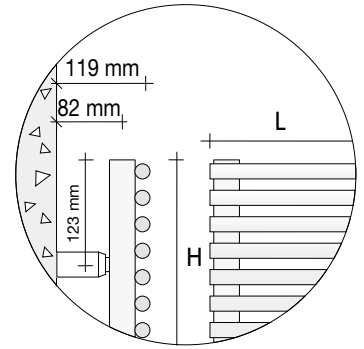



ADDITIONAL CHARGES FOR COLOURS AND FINISHES (see the official Tubes Colour Chart)

RAL colours not included in the colour chart + 30% more than Pure white price (cat. C0), for colours according to samples request feasibility and estimate.
 PLATED finishes: NOT available

Code	H (cm)	L (cm)	Interaxis (Pipe centre) (cm)	Water Content (l)	Coloured version		Category C0 RAL 9010 (€)	Category C1/C2 (€)	Category C3 (€)
					Watts ΔT 50°C	Watts ΔT 30°C			
BA20I5#080040	84,5	40,0	5	3,20	374	203			
BA20I5#080050		50,0	5	4,00	454	219			
BA20I5#080060		60,0	5	4,80	535	247			
BA20I5#120040	119,5	40,0	5	4,50	512	274			
BA20I5#120050		50,0	5	5,63	616	295			
BA20I5#120060		60,0	5	6,75	719	224			
BA20I5#150040	154,5	40,0	5	5,50	656	350			
BA20I5#150050		50,0	5	6,88	786	377			
BA20I5#150060		60,0	5	8,25	916	424			
BA20I5#190040	200,0	40,0	5	7,10	872	460			
BA20I5#190050		50,0	5	8,88	1036	494			
BA20I5#190060		60,0	5	10,65	1201	555			

For correction factors different to ΔT50°C/ΔT30°C see page 284-289

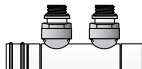
STANDARD VALVES (for Valves and Lockshields, valves that can be fitted with thermostat, Thermostatic valves, or Single pipe, Twin pipe, Stainless steel and thermostatic heads see pages 271, 272, 273, 274 und 275 of the Price List)

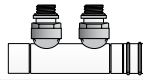
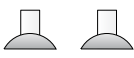
code / Description	Price	code / Description	Price
 Z1TLNR#ANR129010 Paired Valve and Lockshield copper Angle 1/2" WHITE	€	 Z1TL5NR#ANR12SX... Valves with 5 cm Interaxis (Pipe centre) 5 cm - Left	9010 € CHROME €
 Z1RAC#R12CRO 2 copper unions diam. 12 mm	CHROME €	 Z1TL5NR#ANR12DX... Valves with 5 cm Interaxis (Pipe centre) 5 cm - Right	9010 € CHROME €
 ZRCF# Kit with pipe collars for towel warmers	WHITE €		

ORDER EXAMPLE

To correctly order this model follow the example specified below:

PRODUCT	BA20E#080050 U1 ST 9010
BA20E#080050	Article code found in the prices table on the side
U1	Resistance code listed in the next list
ST	Standard Support code, only one support code available for Electric and Mixed version
9010	Colour code found in the TUBES COLOUR CHART

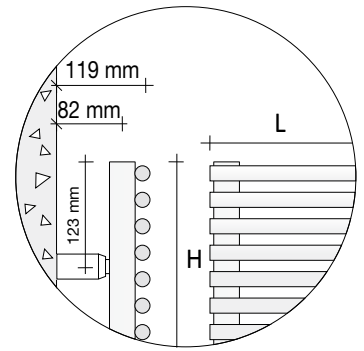

ELECTRIC VERSION WITH EDGE CAP

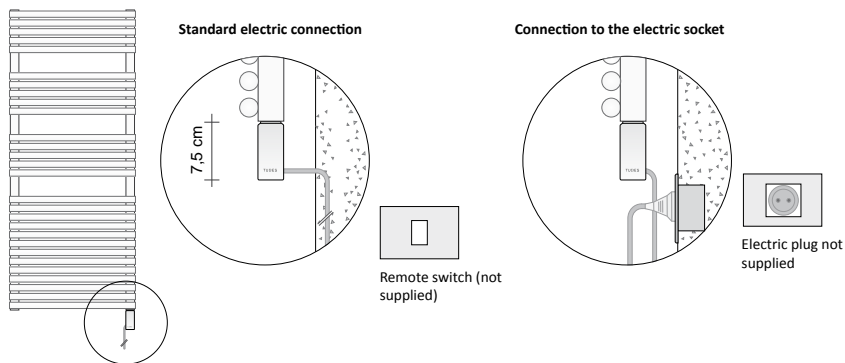

ELECTRIC VERSION WITH THERMOSTAT

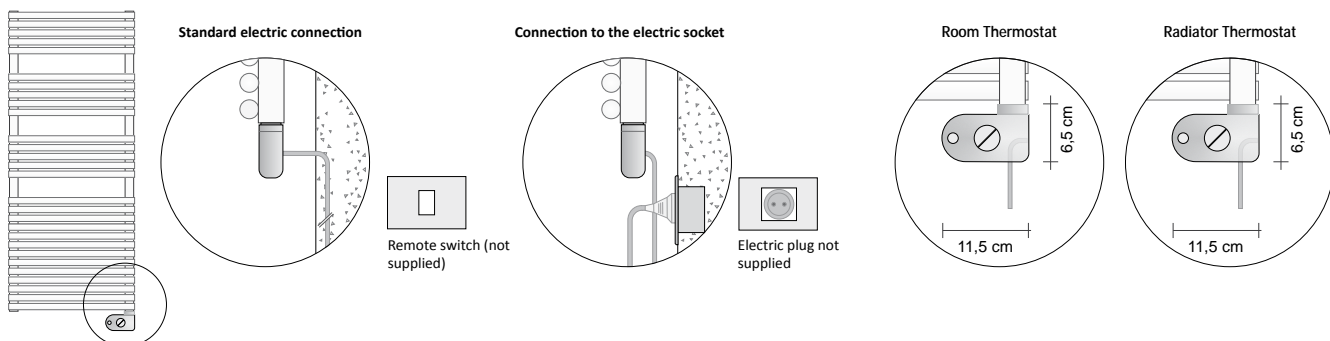

ELECTRIC VERSION WITH WIRELESS THERMOSTAT

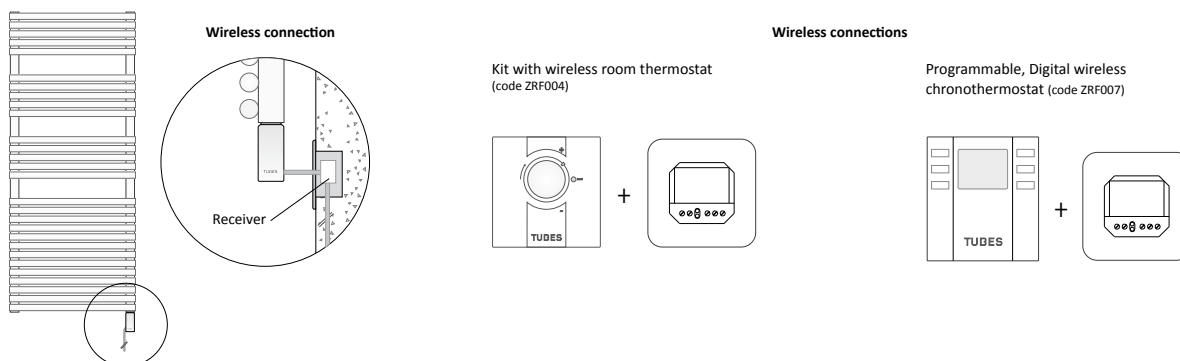

ADDITIONAL CHARGES FOR COLOURS AND FINISHES (see the official Tubes Colour Chart)

For RAL colours not included in the colour chart and according to samples request feasibility and estimate.

PLATED finishes: Nickel Satin finish same price as Glossy CHROME (cat. G1), 14kt GOLD finish (cat. G5) and 24kt gold (cat. G6), request a cost estimate

ELECTRIC VERSION WITH EDGE CAP

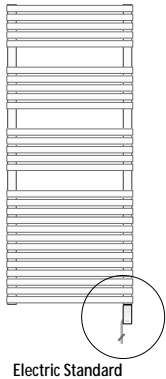

Electric Standard

Model	Edge Cap Colour Code			H (cm)	L (cm)	Electric resistor Watts	Price RAL 9010 CategoryC0 (€)	Price Category C1/C2 (€)	Price Category C3 (€)
	White	Grey	Chrome*						
BA20E#080040	U1	V1	Z1*	80,5	40,0	300			
BA20E#080435	U1	V1	Z1*		43,5	300			
BA20E#080050	U1	V1	Z1*		50,0	300			
BA20E#080535	U1	V1	Z1*		53,5	300			
BA20E#080060	U2	V2	Z2*		60,0	600			
BA20E#080635	U2	V2	Z2*		63,5	600			
BA20E#120040	U1	V1	Z1*	115,5	40,0	300			
BA20E#120435	U1	V1	Z1*		43,5	300			
BA20E#120050	U2	V2	Z2*		50,0	600			
BA20E#120535	U2	V2	Z2*		53,5	600			
BA20E#120060	U2	V2	Z2*		60,0	600			
BA20E#120635	U2	V2	Z2*		63,5	600			
BA20E#150040	U2	V2	Z2*	150,5	40,0	600			
BA20E#150435	U2	V2	Z2*		43,5	600			
BA20E#150050	U2	V2	Z2*		50,0	600			
BA20E#150535	U2	V2	Z2*		53,5	600			
BA20E#150060	U3	V3	Z3*		60,0	900			
BA20E#150635	U3	V3	Z3*		63,5	900			
BA20E#190040	U3	V3	Z3*	196,0	40,0	900			
BA20E#190435	U3	V3	Z3*		43,5	900			
BA20E#190050	U3	V3	Z3*		50,0	900			
BA20E#190535	U3	V3	Z3*		53,5	900			
BA20E#190060	U4	V4	Z4*		60,0	1200			
BA20E#190635	U4	V4	Z4*		63,5	1200			

* Supplied with price surcharge of € 10.00

ELECTRIC VERSION WITH THERMOSTAT

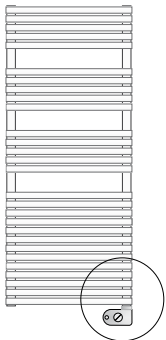

Electric
- Room Thermostat
- Radiator Thermostat

Model	Code Thermostat				H (cm)	L (cm)	Electric resistor Watts	Price RAL 9010 CategoryC0 (€)	Price Category C1/C2 (€)	Price Category C3 (€)
	ROOM THERMOSTAT		RADIATOR							
	White	Chrome	White	Chrome						
BA20E#080040	A5	A7	N1	N5	80,5	40,0	300			
BA20E#080435	A5	A7	N1	N5		43,5	300			
BA20E#080050	A5	A7	N1	N5		50,0	300			
BA20E#080535	A5	A7	N1	N5		53,5	300			
BA20E#080060	B5	B7	N2	N6		60,0	600			
BA20E#080635	B5	B7	N2	N6		63,5	600			
BA20E#120040	A5	A7	N1	N5	115,5	40,0	300			
BA20E#120435	A5	A7	N1	N5		43,5	300			
BA20E#120050	B5	B7	N2	N6		50,0	600			
BA20E#120535	B5	B7	N2	N6		53,5	600			
BA20E#120060	B5	B7	N2	N6		60,0	600			
BA20E#120635	B5	B7	N2	N6		63,5	600			
BA20E#150040	B5	B7	N2	N6	150,5	40,0	600			
BA20E#150435	B5	B7	N2	N6		43,5	600			
BA20E#150050	B5	B7	N2	N6		50,0	600			
BA20E#150535	B5	B7	N2	N6		53,5	600			
BA20E#150060	C5	C7	N3	N7		60,0	900			
BA20E#150635	C5	C7	N3	N7		63,5	900			
BA20E#190040	C5	C7	N3	N7	196,0	40,0	900			
BA20E#190435	C5	C7	N3	N7		43,5	900			
BA20E#190050	C5	C7	N3	N7		50,0	900			
BA20E#190535	C5	C7	N3	N7		53,5	900			
BA20E#190060	D5	D7	N4	N8		60,0	1200			
BA20E#190635	D5	D7	N4	N8		63,5	1200			

ELECTRIC VERSION WITH WIRELESS THERMOSTAT

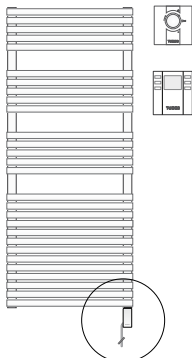

Electric with wireless Thermostat

Model	Edge Cap Colour Code			Wireless Thermostat Code		H (cm)	L (cm)	Electric resistor Watts	Price RAL 9010 CategoryC0 (€)	Price Category C1/C2 (€)	Price Category C3 (€)
	White	Grey	Chrome*	Room Thermostat Kit	Chronothermostat Kit**						
				+ZRF004	+ZRF007**						
BA20E#080040	U1	V1	Z1*	+ZRF004	+ZRF007**	80,5	40,0	300			
BA20E#080435	U1	V1	Z1*	+ZRF004	+ZRF007**		43,5	300			
BA20E#080050	U1	V1	Z1*	+ZRF004	+ZRF007**		50,0	300			
BA20E#080535	U1	V1	Z1*	+ZRF004	+ZRF007**		53,5	300			
BA20E#080060	U2	V2	Z2*	+ZRF004	+ZRF007**		60,0	600			
BA20E#080635	U2	V2	Z2*	+ZRF004	+ZRF007**		63,5	600			
BA20E#120040	U1	V1	Z1*	+ZRF004	+ZRF007**	115,5	40,0	300			
BA20E#120435	U1	V1	Z1*	+ZRF004	+ZRF007**		43,5	300			
BA20E#120050	U2	V2	Z2*	+ZRF004	+ZRF007**		50,0	600			
BA20E#120535	U2	V2	Z2*	+ZRF004	+ZRF007**		53,5	600			
BA20E#120060	U2	V2	Z2*	+ZRF004	+ZRF007**		60,0	600			
BA20E#120635	U2	V2	Z2*	+ZRF004	+ZRF007**		63,5	600			
BA20E#150040	U2	V2	Z2*	+ZRF004	+ZRF007**	150,5	40,0	600			
BA20E#150435	U2	V2	Z2*	+ZRF004	+ZRF007**		43,5	600			
BA20E#150050	U2	V2	Z2*	+ZRF004	+ZRF007**		50,0	600			
BA20E#150535	U2	V2	Z2*	+ZRF004	+ZRF007**		53,5	600			
BA20E#150060	U3	V3	Z3*	+ZRF004	+ZRF007**		60,0	900			
BA20E#150635	U3	V3	Z3*	+ZRF004	+ZRF007**		63,5	900			
BA20E#190040	U3	V3	Z3*	+ZRF004	+ZRF007**	196,0	40,0	900			
BA20E#190435	U3	V3	Z3*	+ZRF004	+ZRF007**		43,5	900			
BA20E#190050	U3	V3	Z3*	+ZRF004	+ZRF007**		50,0	900			
BA20E#190535	U3	V3	Z3*	+ZRF004	+ZRF007**		53,5	900			
BA20E#190060	U4	V4	Z4*	+ZRF004	+ZRF007**		60,0	1200			
BA20E#190635	U4	V4	Z4*	+ZRF004	+ZRF007**		63,5	1200			

* Supplied with price surcharge of € 10.00 - ** The chronothermostat kit comes with an extra charge of € 80.00

The wireless ELECTRIC version consists of two articles, eg BA20E#080040 U1 (Electric Towel warmer with white edge cap) + ZRF004 (Kit Roomthermostat) and the total price is shown in the table. If the customer chooses ZRF007 ** (Chronothermostat kit) at the price indicated in the table must be added the extra price of € 78.00

BATH 20 Mixed

Towel warmer composed of horizontal fusion welded elements in 20 mm diameter steel with 34 mm diam. manifolds

MX

ORDER EXAMPLE

To correctly order this model follow the example specified below:

PRODUCT	BA20M#080050 KU1 ST 9010
BA20M#080050	Article code found in the prices table on the side
ST	Standard Support code, only one support code available for Electric and Mixed version
9010	Colour code found in the TUBES COLOUR CHART

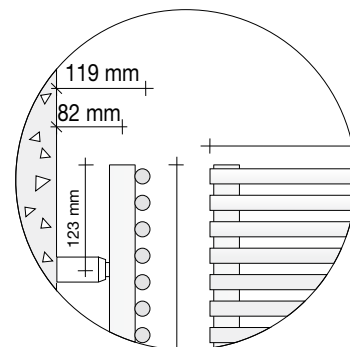

MIXED WITH KIT, EXTERNAL CONNECTOR WITH STANDARD VALVES (code BA20M#...)

MIXED VERSION WITH KIT and external connectors

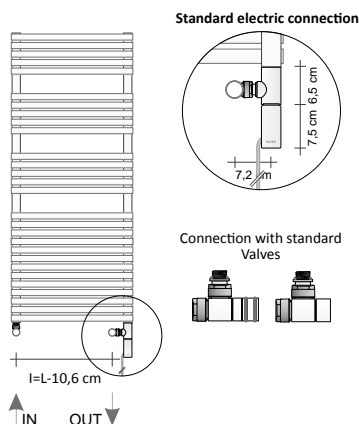

MIXED WITH KIT, REAR CONNECTOR WITH GVR (REMOTE VALVES) (code BA20MS#...)

MIXED VERSION WITH EDGE CAP with rear connectors and GVR

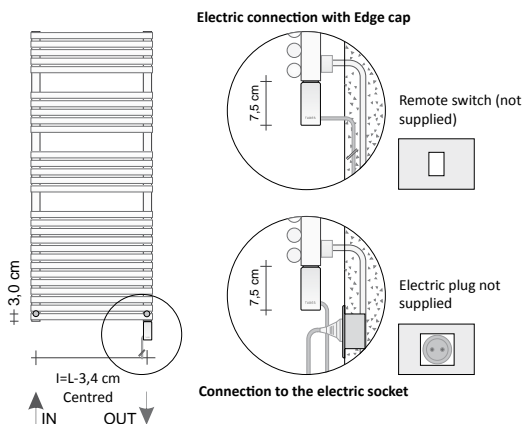

Connection to the Remote Valve Assembly (GVR)

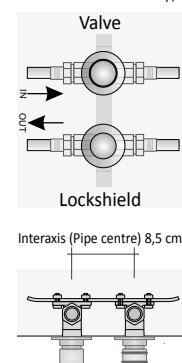

MIXED VERSION WITH KIT AND THERMOSTAT (Room) with external connectors

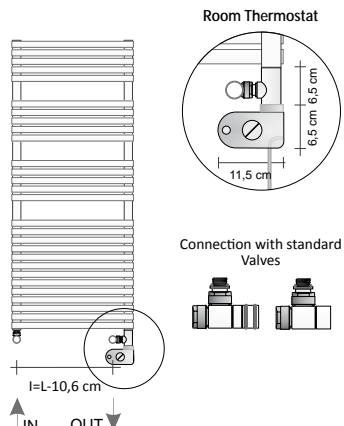

MIXED VERSION WITH THERMOSTAT (Room/Radiator) and rear connectors for GVR (Room/Radiator) and rear connectors for GVR

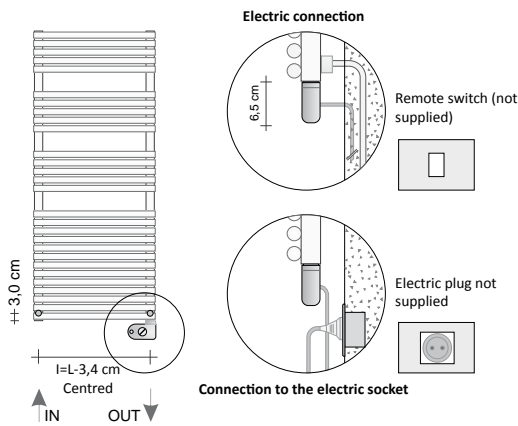

Room Thermostat

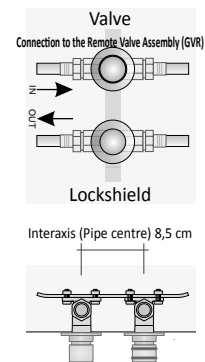
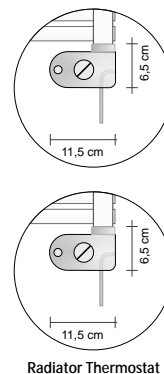

MIXED WITH KIT, WIRELESS THERMOSTAT and external connectors

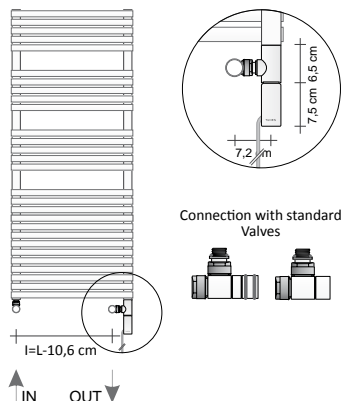

MIXED WITH KIT, WIRELESS THERMOSTAT and rear connectors

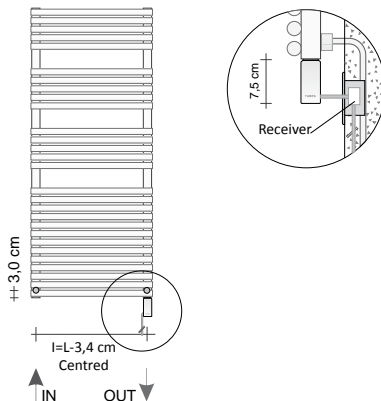

Wireless connections

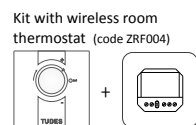

Programmable, Digital wireless chronothermostat (code ZRF007)

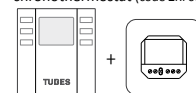

The Room Thermostat Kit and Chronothermostat Kit also includes the receiver for wireless connection

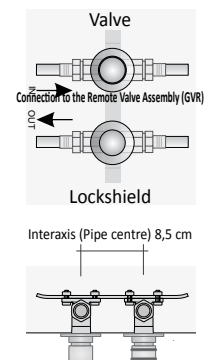

ADDITIONAL CHARGES FOR COLOURS AND FINISHES (see the official Tubes Colour Chart)

For RAL colours not included in the colour chart and according to samples request feasibility and estimate.

PLATED finishes: Nickel Satin finish same price as Glossy CHROME (cat. G1), 14kt GOLD finish (cat. G5) and 24kt gold (cat. G6), request a cost estimate

BATH 20 Mixed

Towel warmer composed of horizontal fusion welded elements in 20 mm diameter steel with 34 mm diam. manifolds



MIXED VERSION - (BA20M means the version with kit and standard valves - BA20MS means the version to be connected by GVR and rear connection)

Connectable Version via		Edge Cap Colour Code			H (cm)	L (cm)	Interaxis (Pipe centre) (cm)	Thermal yield		Electric resistor Watts	Price RAL 9010 CategoryC0 (€)	Price Category C1/C2 (€)	Price Category C3 (€)
Standard Valves	rear connector and GVR	White	Grey	Chrome*				Watts ΔT 50°C	Watts ΔT 30°C				
BA20M#080040	BA20MS#080040	KU1	KV1	KZ1*	80,5	40,0	29,4	374	203	300			
BA20M#080435	BA20MS#080435	KU1	KV1	KZ1*	43,5	32,9	402	219	300				
BA20M#080050	BA20MS#080050	KU1	KV1	KZ1*	50,0	39,4	454	247	300				
BA20M#080535	BA20MS#080535	KU1	KV1	KZ1*	53,5	42,9	483	263	300				
BA20M#080060	BA20MS#080060	KU2	KV2	KZ2*	60,0	49,4	535	291	600				
BA20M#080635	BA20MS#080635	KU2	KV2	KZ2*	63,5	52,9	563	307	600				
BA20M#120040	BA20MS#120040	KU1	KV1	KZ1*	115,5	40,0	29,4	512	274	300			
BA20M#120435	BA20MS#120435	KU1	KV1	KZ1*	43,5	32,9	548	295	300				
BA20M#120050	BA20MS#120050	KU2	KV2	KZ2*	50,0	39,4	616	224	600				
BA20M#120535	BA20MS#120535	KU2	KV2	KZ2*	53,5	42,9	652	350	600				
BA20M#120060	BA20MS#120060	KU2	KV2	KZ2*	60,0	49,4	719	388	600				
BA20M#120635	BA20MS#120635	KU2	KV2	KZ2*	63,5	52,9	755	410	600				
BA20M#150040	BA20MS#150040	KU2	KV2	KZ2*	150,5	40,0	29,4	656	350	600			
BA20M#150435	BA20MS#150435	KU2	KV2	KZ2*	43,5	32,9	702	377	600				
BA20M#150050	BA20MS#150050	KU2	KV2	KZ2*	50,0	39,4	786	424	600				
BA20M#150535	BA20MS#150535	KU2	KV2	KZ2*	53,5	42,9	832	444	600				
BA20M#150060	BA20MS#150060	KU3	KV3	KZ3*	60,0	49,4	916	493	900				
BA20M#150635	BA20MS#150635	KU3	KV3	KZ3*	63,5	52,9	962	521	900				
BA20M#190040	BA20MS#190040	KU3	KV3	KZ3*	196,0	40,0	29,4	872	460	900			
BA20M#190435	BA20MS#190435	KU3	KV3	KZ3*	43,5	32,9	929	494	900				
BA20M#190050	BA20MS#190050	KU3	KV3	KZ3*	50,0	39,4	1036	555	900				
BA20M#190535	BA20MS#190535	KU3	KV3	KZ3*	53,5	42,9	1094	579	900				
BA20M#190060	BA20MS#190060	KU4	KV4	KZ4*	60,0	49,4	1201	641	1200				
BA20M#190635	BA20MS#190635	KU4	KV4	KZ4*	63,5	52,9	1258	676	1200				

* Supplied with price surcharge of € 10.00

MIXED VERSION WITH THERMOSTAT (Room/Radiator) and rear connectors for GVR - (BA20M means the version with kit and standard valves - BA20MS means the version to be connected by GVR and rear connection)

Connectable Version via		Code Thermostat				H (cm)	L (cm)	Interaxis (Pipe centre) (cm)	Thermal yield		Electric resistor Watts	Price RAL 9010 CategoryC0 (€)	Price Category C1/C2 (€)	Price Category C3 (€)
Standard Valves	rear connector and GVR	ROOM THERMO-STAT		RADIATOR					Watts ΔT 50°C	Watts ΔT 30°C				
		White	Chrome	White	Chrome									
BA20M#080040	BA20MS#080040	KA5	KA7	KN1	KN5	80,5	40,0	29,4	374	203	300			
BA20M#080435	BA20MS#080435	KA5	KA7	KN1	KN5	43,5	32,9	402	219	300				
BA20M#080050	BA20MS#080050	KA5	KA7	KN1	KN5	50,0	39,4	454	247	300				
BA20M#080535	BA20MS#080535	KA5	KA7	KN1	KN5	53,5	42,9	483	263	300				
BA20M#080060	BA20MS#080060	KB5	KB7	KN2	KN6	60,0	49,4	535	291	600				
BA20M#080635	BA20MS#080635	KB5	KB7	KN2	KN6	63,5	52,9	563	307	600				
BA20M#120040	BA20MS#120040	KA5	KA7	KN1	KN5	115,5	40,0	29,4	512	274	300			
BA20M#120435	BA20MS#120435	KA5	KA7	KN1	KN5	43,5	32,9	548	295	300				
BA20M#120050	BA20MS#120050	KB5	KB7	KN2	KN6	50,0	39,4	616	224	600				
BA20M#120535	BA20MS#120535	KB5	KB7	KN2	KN6	53,5	42,9	652	350	600				
BA20M#120060	BA20MS#120060	KB5	KB7	KN2	KN6	60,0	49,4	719	388	600				
BA20M#120635	BA20MS#120635	KB5	KB7	KN2	KN6	63,5	52,9	755	410	600				
BA20M#150040	BA20MS#150040	KB5	KB7	KN2	KN6	150,5	40,0	29,4	656	350	600			
BA20M#150435	BA20MS#150435	KB5	KB7	KN2	KN6	43,5	32,9	702	377	600				
BA20M#150050	BA20MS#150050	KB5	KB7	KN2	KN6	50,0	39,4	786	424	600				
BA20M#150535	BA20MS#150535	KB5	KB7	KN2	KN6	53,5	42,9	832	444	600				
BA20M#150060	BA20MS#150060	KC5	KC7	KN3	KN7	60,0	49,4	916	493	900				
BA20M#150635	BA20MS#150635	KC5	KC7	KN3	KN7	63,5	52,9	962	521	900				
BA20M#190040	BA20MS#190040	KC5	KC7	KN3	KN7	196,0	40,0	29,4	872	460	900			
BA20M#190435	BA20MS#190435	KC5	KC7	KN3	KN7	43,5	32,9	929	494	900				
BA20M#190050	BA20MS#190050	KC5	KC7	KN3	KN7	50,0	39,4	1036	555	900				
BA20M#190535	BA20MS#190535	KC5	KC7	KN3	KN7	53,5	42,9	1094	579	900				
BA20M#190060	BA20MS#190060	KD5	KD7	KN4	KN8	60,0	49,4	1201	641	1200				
BA20M#190635	BA20MS#190635	KD5	KD7	KN4	KN8	63,5	52,9	1258	676	1200				

MIXED VERSION WITH WIRELESS THERMOSTAT - (BA20M means the version with kit and standard valves - BA20MS means the version to be connected by GVR and rear connection)

Connectable Version via		Edge Cap Colour Code			Wireless Thermostat Code		H (cm)	L (cm)	Interaxis (Pipe centre) (cm)	Thermal yield		Electric resistor Watts	Price RAL 9010 CategoryC0 (€)	Price Category C1/C2 (€)	Price Category C3 (€)
Standard Valves	rear connector and GVR	White	Grey	Chrome*	Room Thermostat Kit	Chronothermostat Kit**				Watts ΔT 50°C	Watts ΔT 30°C				
BA20M#080040	BA20MS#080040	KU1	KV1	KZ1*	+ZRF004	+ZRF007**	80,5	40,0	29,4	374	203	300			
BA20M#080435	BA20MS#080435	KU1	KV1	KZ1*	+ZRF004	+ZRF007**	43,5	32,9	402	219	300				
BA20M#080050	BA20MS#080050	KU1	KV1	KZ1*	+ZRF004	+ZRF007**	50,0	39,4	454	247	300				
BA20M#080535	BA20MS#080535	KU1	KV1	KZ1*	+ZRF004	+ZRF007**	53,5	42,9	483	263	300				
BA20M#080060	BA20MS#080060	KU2	KV2	KZ2*	+ZRF004	+ZRF007**	60,0	49,4	535	291	600				
BA20M#080635	BA20MS#080635	KU2	KV2	KZ2*	+ZRF004	+ZRF007**	63,5	52,9	563	307	600				
BA20M#120040	BA20MS#120040	KU1	KV1	KZ1*	+ZRF004	+ZRF007**	115,5	40,0	29,4	512	274	300			
BA20M#120435	BA20MS#120435	KU1	KV1	KZ1*	+ZRF004	+ZRF007**	43,5	32,9	548	295	300				
BA20M#120050	BA20MS#120050	KU2	KV2	KZ2*	+ZRF004	+ZRF007**	50,0	39,4	616	224	600				
BA20M#120535	BA20MS#120535	KU2	KV2	KZ2*	+ZRF004	+ZRF007**	53,5	42,9	652	350	600				
BA20M#120060	BA20MS#120060	KU2	KV2	KZ2*	+ZRF004	+ZRF007**	60,0	49,4	719	388	600				
BA20M#120635	BA20MS#120635	KU2	KV2	KZ2*	+ZRF004	+ZRF007**	63,5	52,9	755	410	600				
BA20M#150040	BA20MS#150040	KU2	KV2	KZ2*	+ZRF004	+ZRF007**	150,5	40,0	29,4	656	350	600			
BA20M#150435	BA20MS#150435	KU2	KV2	KZ2*	+ZRF004	+ZRF007**	43,5	32,9	702	377	600				
BA20M#150050	BA20MS#150050	KU2	KV2	KZ2*	+ZRF004	+ZRF007**	50,0	39,4	786	424	600				
BA20M#150535	BA20MS#150535	KU2	KV2	KZ2*	+ZRF004	+ZRF007**	53,5	42,9	832	444	600				
BA20M#150060	BA20MS#150060	KU3	KV3	KZ3*	+ZRF004	+ZRF007**	60,0	49,4	916	493	900				
BA20M#150635	BA20MS#150635	KU3	KV3	KZ3*	+ZRF004	+ZRF007**	63,5	52,9	962	521	900				
BA20M#190040	BA20MS#190040	KU3	KV3	KZ3*	+ZRF004	+ZRF007**	196,0	40,0	29,4	872	460	900			
BA20M#190435	BA20MS#190435	KU3	KV3	KZ3*	+ZRF004	+ZRF007**	43,5	32,9	929	494	900				
BA20M#190050	BA20MS#190050	KU3	KV3	KZ3*	+ZRF004	+ZRF007**	50,0	39,4	1036	555	900				
BA20M#190535	BA20MS#190535	KU3	KV3	KZ3*	+ZRF004	+ZRF007**	53,5	42,9	1094	579	900				
BA20M#190060	BA20MS#190060	KU4	KV4	KZ4*	+ZRF004	+ZRF007**	60,0	49,4	1201	641	1200				
BA20M#190635	BA20MS#190635	KU4	KV4	KZ4*	+ZRF004	+ZRF007**	63,5	52,9	1258	676	1200				

* Supplied with price surcharge of € 10.00 - ** The chronothermostat kit comes with an extra charge of € 80.00

The wireless MIXED version consists of two articles, eg.: BA20M#080040 KU1 (MIXED Towel warmer with white edge cap) + ZRF004 (Kit Roomthermostat) and the total price is shown in the table. If the customer chooses ZRF007 ** (Chronothermostat kit) at the price indicated in the table must be added the extra price of € 78.00